

Other HEMCO Products



UniFlow CE AirStream



UniFlow SE AirStream High Performance Energy Efficient Laboratory Fume Hoods



UniFlow LE AirStream



UniFlow LE FM



Safety Equipment



Visit www.HEMCOcorp.com

HEMCO Corporation
711 S. Powell Road
Independence MO, 64056
MM-SOFTWALLCR.04.23

HEMCO
Lab Planning Solutions

Email info@HEMCOcorp.com
Phone (816) 796-2900
Fax (816) 796-3333

Installation, Operation, Maintenance Manual Softwall Cleanrooms



HEMCO Visit www.HEMCOcorp.com
Lab Planning Solutions

HEMCO Corporation
711 S. Powell Road
Independence MO, 64056

Email info@HEMCOcorp.com
Phone (816)796-2900
Fax (816)796-3333



Table of Contents

Notes:

PROJECT INFORMATION.....	2
INSTALLATION	3
OPERATION.....	3
START-UP.....	3
DAILY OPERATION	3
FILTER MATERIAL CONCERNS.....	3
PREVENTIVE MAINTENANCE.....	4
REPLACEMENT FILTERS/ITEMS.....	4
PROJECT DRAWINGS.....	5
SAM FILTER OPERATING MANUAL	6
MAGNEHELIC GAGE INSTRUCTIONS.....	15

Project Information

Filtered Weigh Room
Modular room is mobile and filters air both in and out.

Room is constructed and equipped with:

- Modular wall panel construction. Panels are 2” thick with rigid foam core and faced on both sides with chemical resistant, non-porous, easily cleaned composite resin surface skin panels
- Structural framework is of anodized aluminum extrusions.
- Front to have a clear vinyl strip curtain for entry
- A window of clear acrylic would be located on each side
- A fan-powered HEPA filter is located in the ceiling providing a minimum of class 100,000 into the room. The filter is 2’x 4’ and 99.99% eff. A speed control is mounted on the filter module for balancing
- A fan powered HEPA filter is also mounted on the rear wall (either at floor level or bench level) that exhausts air out of the room back to the surrounding area. The filter is 2’x 4’ and 99.99% eff. and a speed control is provided for balancing
- (2) Shatterproof fluorescent light fixtures are ceiling mounted
- Electrical, switches, and minihelic gage are provided
- Room shall position on a welded steel lower frame with leveling casters. These allow the room to be lowered to set on the floor and raised for moving.
- An electrical plug strip is provided on rear and side walls inside. 115v 15 amp

Magnehelic Gage Exploded View

Magnehelic Gage
EXPLODED VIEW
Series 2000

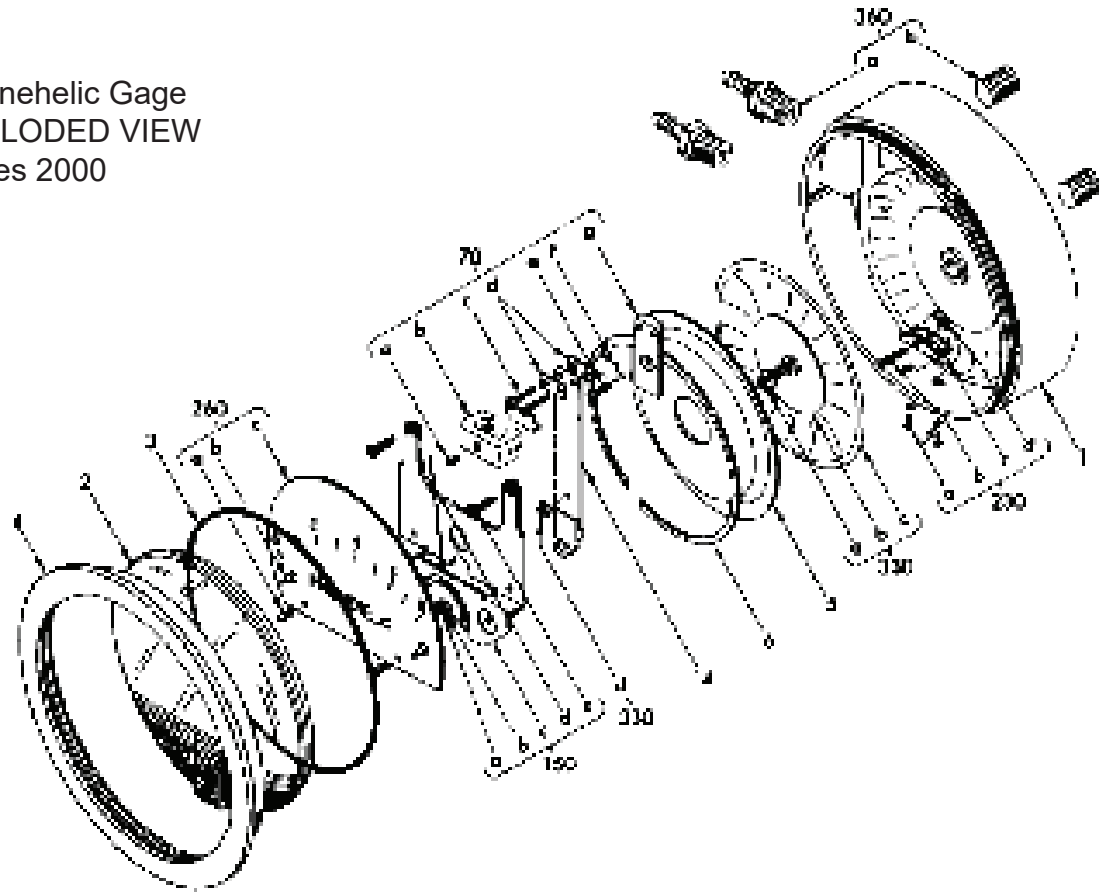

1. Case
2. Cover with zero adjust assy.
3. "O" ring seal
4. Bezel
5. Diaphragm sealing plate
6. Retaining ring
70. Range Spring assembly
 - a. lamp set screw
 - b. Clamp
 - c. Mounting screws (2 req'd)
 - d. Clamping shoe (2 req'd)
 - e. Clamp plate screw
 - f. Spacer (2 req'd)
 - g. Clamp plate
14. Range Spring with magnet
50. Wishbone Assembly -consists of:
 - a. Front jewel
 - b. Locking nut
 - C. Wishbone
 - d. Pointer a' Mounting screws (2 req'd)
 - f. Helix assembly (not shown)
 - g. Pivots (2 req'd) (not shown)
 - h. Hear jewel (not shown)

230. Zero adjust assembly -consists of:
 - a. Foot screws with washers (2 req'd)
 - b. Adjust screw
 - c. Foot
 - d. Finger
260. Scale Assembly -consists of:
 - a. Mounting screws (2 req'd)
 - b. Bumper pointer stop (2 req'd)
 - c. Scale
330. Diaphragm Assembly -consists of:
(Arbor press needed to install)
 - a. Linkage assy., complete
 - b. Front plate
 - c. Diaphragm
 - d. Rear plate (not shown)
 - e. Plate washer (not shown)
360. Mounting Hardware Kit
 - a. Adapter -pipe plug 1/8"@NPT to rubber tubing -(2 req'd)
 - b. Pipe plug 1/8"NP -(2 req'd)
 - c. Mounting lug (3 req'd)
 - d. Long screw (3 req'd)
 - e. Short screw (3 req'd)

Cleanroom Installation

Installation

Shipped Complete. Remove from packing materials and commission in accordance with standard industry practices, component manufacturers guidelines and site specific adjustments. Component manuals attached.

Operation

Start-Up

1. Interior surfaces other than filter faces need to be wiped down with lint-particle free cloth and a general purpose cleaner (can be 50/50 mix of water and isopropyl alcohol.)
2. Check and Commission Fan Filter Units and light fixtures as per component manuals.
3. Allow room to stabilize for 12-16 hours prior to certification testing, and/or production use.
4. Note and mark magnehelic gage initial reading. Multiply this reading by 1.5 to 2.0 times to calculate filter change setting. Mark this set point also on the gage face for future filter maintenance intervals. Marking can be directly on the gage face with china marker or small self-adhesive labels.

Daily Operation

1. Room stabilization – Any time the unit has been taken off-line (fan filter units have been turned off) Allow the room to stabilize for 12-16 hours prior to re-certification testing, and/or production use.

Filter Material Concerns

1. **CAUTION: HEPA filter media is fragile and can be damaged easily. Special precautions must be followed to avoid damage to the filter media. DO NOT PLACE HANDS OR ANY OTHER OBJECTS ON THE FILTER SURFACE.**

Preventive Maintenance

Preventative Maintenance

A program of preventive maintenance will greatly increase fan and motor life. Inspect pre-filter, fan wheel, motor, and HEPA filter after the first three (3) months of operation. Based on the findings, schedule periodic inspections and maintenance for:

1. Changing 30% prefilters.
2. Cleaning fan wheel is required to insure smooth quiet operation. Periodic cleaning of all fan equipment is strongly recommended because dirt accumulation on the impeller can cause vibration which greatly increases stress and load on motor bearings.
3. Changing the HEPA filter.
Pre-filters normally are changed 3-5 times before the HEPA filter will need replacement.

Replacement Filters/Items

Please reference component installation manuals for replacement part numbers. For faster service please have the serial number of the unit handy when you call or email.

HEMCO Corporation
711 South Powell Road
Independence, Missouri 64056
816-796-2900 Phone
816-796-3333 Fax
info@HEMCOcorp.com

Magnehelic Maintenance

Maintenance: No lubrication or periodic servicing is required. Keep case exterior and cover clean. Occasionally disconnect pressure lines to vent both sides of gage to atmosphere and re-zero. Optional vent valves, (bulletin S-101), should be used in permanent installations.

Calibration Check: Select a second gage or manometer of known accuracy and in an appropriate range. Using short lengths of rubber or vinyl tubing, connect the high-pressure side of the Magnehelic gage and the test gage to two legs of a tee. Very slowly apply pressure through the third leg. Allow a few seconds for pressure to equalize, fluid to drain, etc., and compare readings. If accuracy unacceptable, gage may be returned to factory for recalibration. To calibrate in the field, use the following procedure.

Calibration:

1. With gage case, P/N 1, held firmly, loosen bezel, P/N 4 by turning counterclockwise. To avoid damage, a canvas strap wrench or similar tool should be used.
2. Lift out plastic cover and "O" ring.
3. Remove scale screws and scale assembly. Be careful not to damage pointer.
4. The calibration is changed by moving the clamp, P/N. 70-b. Loosen the clamp screw(s) and move slightly toward the helix if gage is reading high, and away if reading low. Tighten clamp screw and install scale assembly.
5. Place cover and O-ring in position. Make sure the hex shaft on inside of cover is properly engaged in zero adjust screw, P/N 230-b.
6. Secure cover in place by screwing bezel down snug. Note that the area under the cover is pressurized in operation and therefore gage will leak if not properly tightened.
7. Zero gage and compare to test instrument. Make further adjustments as necessary.

Caution: If bezel binds when installing, lubricate threads sparingly with light oil or molybdenum disulphide compound.

Warning: Attempted field repair may void your warranty. Recalibration or repair by the user is not recommended. For best results, return gage to the factory.

Trouble Shooting Tips:

- Gage won't indicate or is sluggish.
 1. Duplicate pressure port not plugged.
 2. Diaphragm ruptured due to overpressure.
 3. Fittings or sensing lines blocked, pinched, or leaking.
 4. Cover loose or "O" ring damaged, missing.
 5. Pressure sensors, (static tips, Pitot tube, etc.) improperly located.
 6. Ambient temperature too low. For operation below 20°F order gage with low temperature, (LT) option. -
- Pointer stuck-gage can't be zeroed.
 1. Scale touching pointer.
 2. Spring/magnet assembly shifted and touching helix.
 3. Metallic particles clinging to magnet and interfering with helix movement.
 4. Cover zero adjust shaft broken or not properly engaged in P/N 230-b adjusting screw.

We generally recommend that gages needing repair be returned to the factory. Parts used in various sub-assemblies vary from one range of gage to another, and use of incorrect components may cause improper operation or failure. Gages repaired at the factory are carefully calibrated and tested to assure "like-new" operation. After receipt and inspection, we will be happy to quote repair costs before proceeding. Consult factory for assistance on unusual applications or conditions. Use with air or compatible gases only.

Magnehelic Installation

Overpressure Protection: Standard Magnehelic gages are rated for a maximum pressure of 15 PSIG and should not be used where that limit could be exceeded. Newer models employ a rubber plug on the rear which functions as a relief valve by unseating and venting the gage interior when overpressure reaches approximately 25 PSIG. To provide a free path for pressure relief, there are four spacer pads, which maintain .040" clearance when gage is surface mounted. Do not obstruct the gap created by these pads.

1. Select a location free from excessive vibration and where the ambient temperature will not exceed 140°F. Also, avoid direct sunlight, which accelerates discoloration of the clear plastic cover. Sensing lines may be run any necessary distance. Long tubing lengths will not affect accuracy but will increase response time slightly. Do not restrict lines. If pulsating pressures or vibration cause excessive pointer oscillation, consult the factory for ways to provide additional damping.

2. All standard Magnehelic gages are calibrated with the diaphragm vertical and should be used in that position for maximum accuracy. If gages are to be used in other than vertical position, this should be specified on the order. Many higher range gages will perform within tolerance in other positions with only re-zeroing. Low range Model 2000-00 and metric equivalents must be used in the vertical position only.

3. Surface Mounting

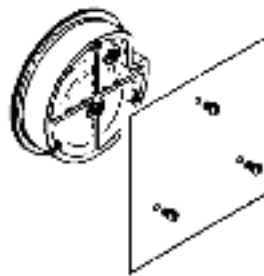

3. Locate mounting holes, 120' apart on a 4-1/8" dia. circle. Use No. 6-32 machine screws of appropriate length

4. Flush Mounting

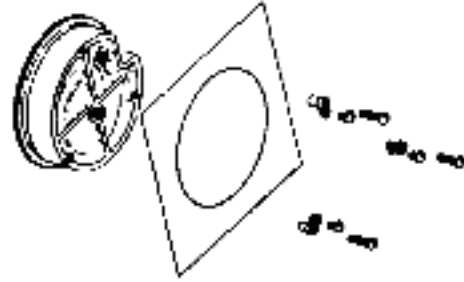

Provide a 4-1/2" dia. opening in panel. Insert gage and secure in place with No. 6-32 machine screws of appropriate length, with adaptors, Part No. 360c, firmly secured in place. To mount gage on 11/4"-2" pipe, order optional A-610 pipe mounting kit

5. To zero the gage after installation Set the indicating pointer exactly on the zero mark, using the external zero adjusts screw on the cover at the bottom. Note that the zero check or adjustment can only be made with the high and low pressure taps both open to atmosphere.

Operation

Positive Pressure: Connect tubing from source of pressure to either of the two high-pressure ports. Plug the port not used. Vent one or both low-pressure ports to atmosphere.

Negative Pressure: Connect tubing from source of vacuum or negative pressure to either of the two low-pressure ports. Plug the port not used. Vent one or both high-pressure ports to atmosphere.

Differential Pressure: Connect tubing from the greater of two pressure sources to either high pressure port and the lower to either low pressure port. Plug both unused ports. When one side of gage is vented in a dirty, dusty atmosphere, we suggest an A-331 Filter Vent Plug be installed in the open port to keep inside of gage clean.

- a. For portable use or temporary installation, use 1/8" pipe thread to rubber tubing adapter and connect to source of pressure with rubber or Tygon tubing.
- b. For permanent installation, 1/4" O. D., or larger, copper or aluminum tubing is recommended. See accessory bulletin S-101 for fittings.

Project Drawing

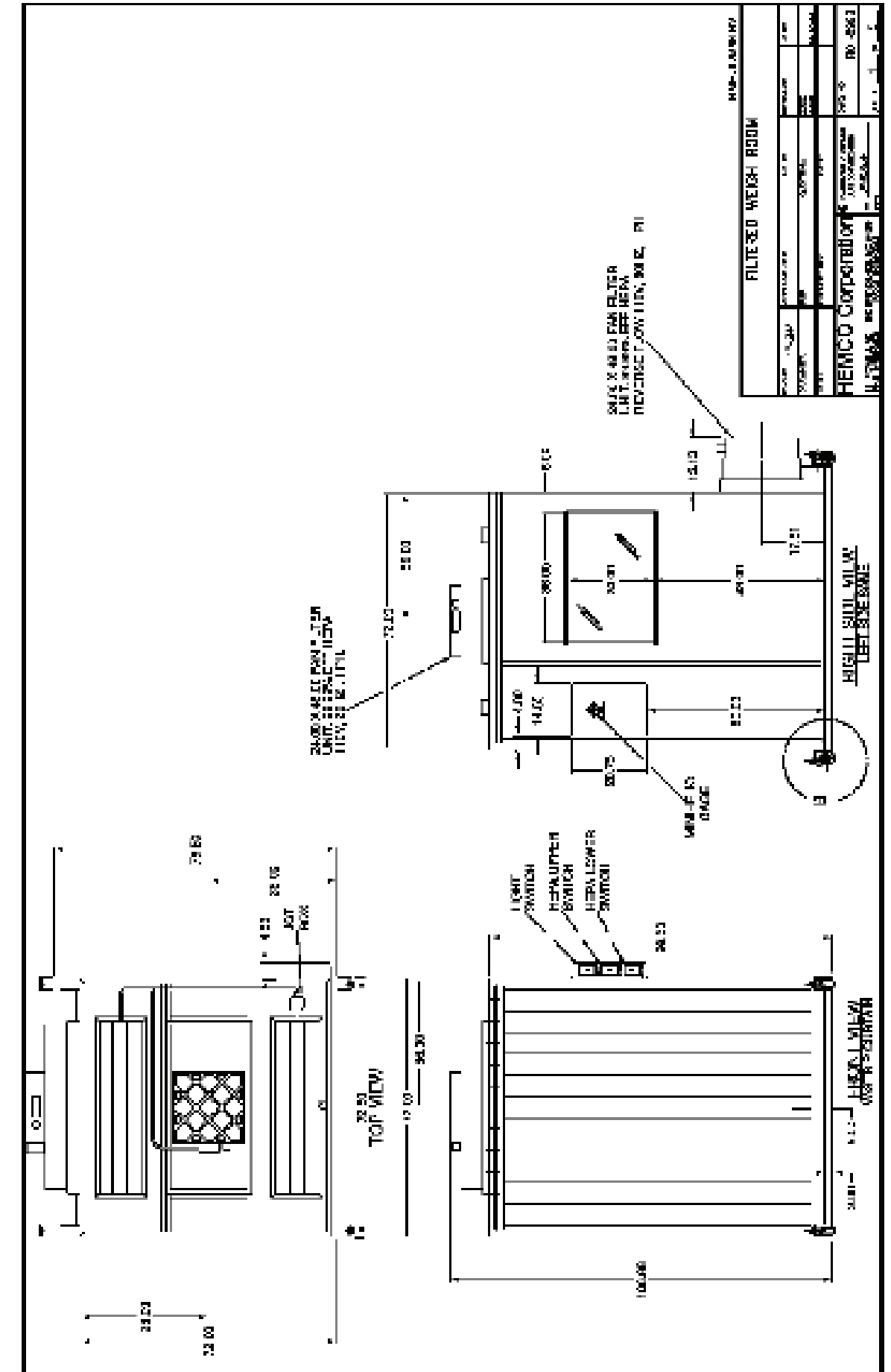

Wiring Diagrams

Wiring Diagrams for all Sam Models with 280LW or MW motors

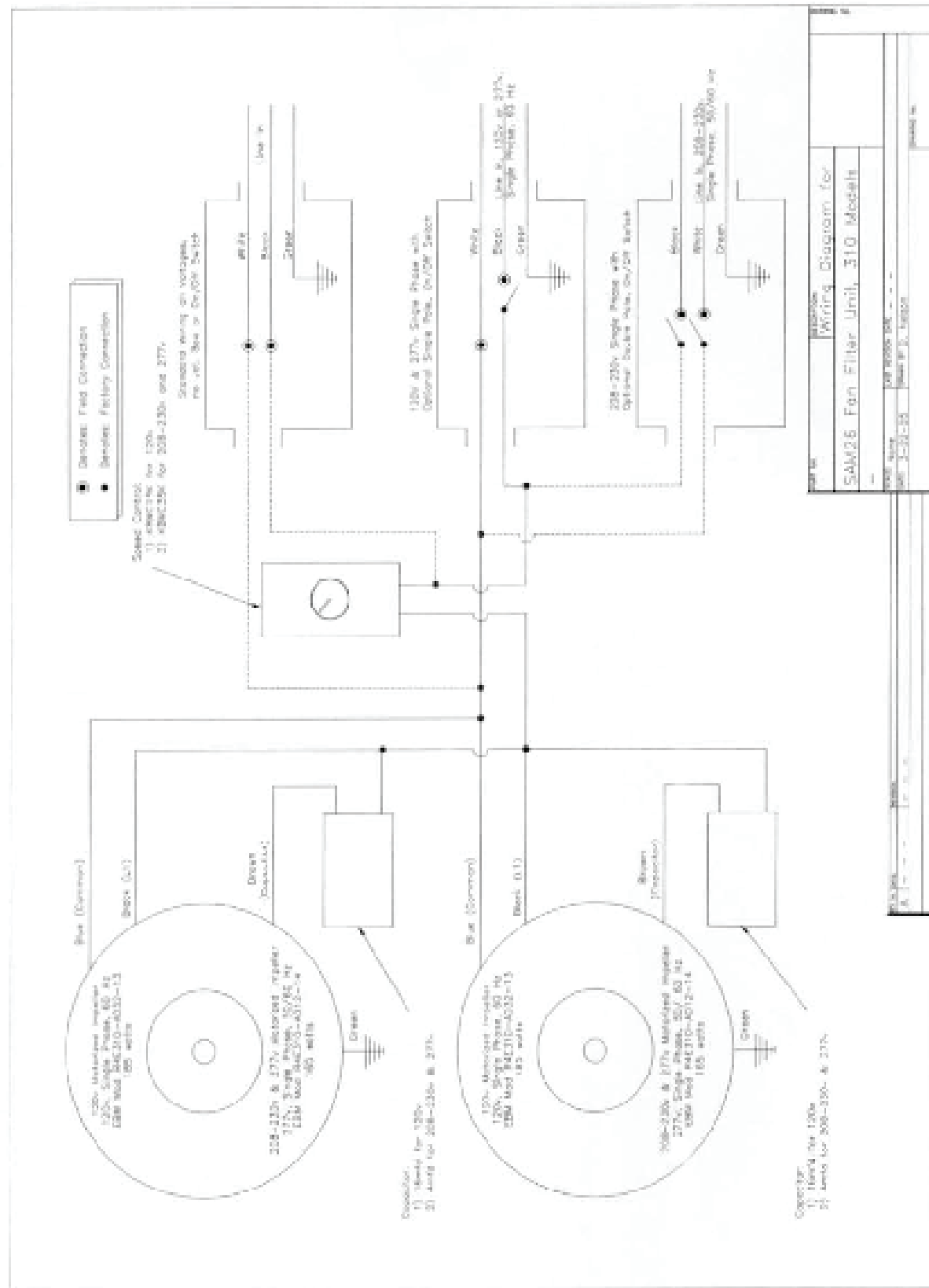

SAM Filter Unit Manual

WARNING- TO REDUCE THE RISK OF FIRE, ELECTRICAL SHOCK, OR INJURY TO PERSONS, OBSERVE THE FOLLOWING:

PRE-INSTALLATION INSTRUCTIONS WARNING- TO REDUCE THE RISK OF FIRE, ELECTRICAL SHOCK, OR INJURY TO PERSONS, OBSERVE THE FOLLOWING:

Use this unit only in the manner intended by the manufacturer. If you have questions, contact the manufacturer.

Installation work and electrical wiring must be done by qualified person(s) in accordance with all applicable codes and standards, including fire-rated construction. SAM Fan Filter Units operate on 115 Volts, 208-230 Volts, 277 Volts at 60 Hz., or 208-240 Volts, 50 Hz. Check the label on the front of the unit for voltage, current and frequency of operation. Verify the rating of the branch circuit protector and branch circuit wiring prior to installation and electrical connection to the unit.

Before servicing or cleaning unit, switch power off at service panel and lock the service disconnecting means to prevent power from being switched on accidentally. When the service disconnecting means cannot be locked, securely fasten a prominent warning device, such as a tag, to the service panel.

Certain models are provided with an optional flexible power cord with plug, Do not use any type of adapter that will allow the unit to be plugged into an outlet that is not grounded.

SAM Fan Filter Units are suitable for commercial and industrial use only. They are designed for suspended installation or installation in T-Grid Ceiling Systems for Vertical Flow.

Do not plug the unit into an outlet that is controlled by an on/off wall switch or by a facility house lighting control switch.

SAM Fan Filter Units must never be exposed to rain, ice, snow, or excessive moisture. Do not use this product near water, i.e. near bathtubs, washbowls, whirlpools, etc. If the unit is equipped with a flexible power cord, do not handle with wet hands.

CAUTION: To Reduce the risk of injury to persons, install the unit at least 7 feet above grade or in ceiling.

Do not place anything on top of the units. Do not restrict the flow of air into the unit.

INSTALLATION INSTRUCTIONS

CAUTION - HEPA and ULPA filter media is fragile and can be damaged easily. Special precautions must be taken during un-packaging and installation of SAM Fan Filter Units. To avoid damage to the filter media, touch only the frame. DO NOT PLACE HANDS OR ANY OTHER OBJECTS ON THE FILTER SURFACE.

RECEIVING AND UNPACKING

All shipments are "FOB Ship Point". This means once goods are picked up and signed for by the driver, they are the responsibility of the freight company. When the shipment is delivered and signed for by your receiving personnel, the ownership and responsibility is transferred to the receiving company.

CAUTION: Most commercially available 1" or 1-1/2" T-Grid suspended false ceiling systems are not designed and installed to support the weight of any fan powered filter units. HEMCO Corporation supplied 1-1/2" and 2" T-Grid systems for softwall and hardwall cleanrooms do not provide the support for direct mounting of SAM Fan Filter Units. If HEMCO Corporation or equivalent 2" T-Grid system is not installed, it is mandatory that SAM Fan Filter Units be suspended independently from these false ceilings.

All items are inspected prior to packaging and are HEMCO does not ship damaged goods. inspect the incoming shipment with the freight carrier driver present. Note any suspected damage on the receiving papers and immediately inspect the damaged carton(s). Note damages on the receiving documents and file a freight claim with the transportation company.

HEMCO Corporation does not take responsibility for damages caused by the freight company.

Mechanical Installation of Suspended Vertical Flow Units:

SAM Fan Filter Units are equipped with attachment points to make the installation hanging process easy. Units may be supported with flexible or rigid hangers. Use at least 12 gage hanging wire or the equivalent light chain or cable on each corner to support the unit.

If damage is discovered after the carton is opened, it is the buyer's/receiver's responsibility to file a freight claim. Keep all incoming cartons and the product for inspection. Do not send back to HEMCO or any of our drop ship companies.

SAM Filter Unit Manual

Mechanical Installation of Units in 2" T-Grid Systems:

Install 2" T-Grid system in accordance with site plan and manufacturers instructions. Install seal gaskets (if provided) in pre-designated locations. Carefully place SAM Fan Filter Unit into the grid opening taking care to observe the precautions not to damage the filter media while handling the units.

Electrical Installation:

Refer to wiring schematics at the back pages of these instructions.

Provision of electrical branch circuit supply to the appropriate location within close proximity to the SAM Fan Filter Units is the responsibility of the customer's electrical installer. If local or national electrical codes or the customer's installation specifications require the provision of metal conduit directly to the unit it is recommended that a Listed flexible metal conduit be provided.

SAM Fan Filter Units may be supplied with optional flexible power cord with grounded plug, optional 2"x 4" or 4"x 4" Metallic wiring box with cover, with or without an on-off switch mounted in the wiring box or optionally within the prefilter frame housing. When an on-off switch is provided, field connections are to be made directly to the open supply terminals of the switch. When an on-off switch is not provided, field connections are to be made to the non-connected pigtail leads within the metallic wiring box or pre-filter frame.

CAUTION: When making field wiring connections within the Pre-Filter Frame, make sure that all field installed wiring is routed away from moving motor and fan parts and is secured in place to prevent inadvertent damage to wires.

Start-up Check List-Before Applying Power:

Check the voltage on the Manufacturer's Name Plate and verify that the power supplied to the unit is the same as that listed on the Name Plate. Remove the prefilter and determine if the fan is free to rotate and misaligned during shipment or installation. Check nuts, bolts, screws and electrical connections for tightness.

CAUTION: If the unit is provided with a square perforated metal barrier over the opening to the prefilter frame, it must be re-installed prior to application of power and start-up of the Fan Filter Units.

Apply power and check that the wheel is rotating in the correct direction. Looking through the prefilter frame the fan must be rotating in a clockwise direction.

OPERATING INSTRUCTIONS

Principle of Operation:

SAM Fan Filter Units are self-contained, low profile, electric powered, motor-fan driven HEPA or ULPA Filter, air filtering appliances. The units are heavy-duty units suitable for many industrial/commercial applications where clean air is needed. This is accomplished by maintaining a flow of filtered air to remove airborne particles within an enclosed room or chamber. Where manufacturing and assembly processes require Federal Standard 209 or ISO Classification clean rooms, multiple SAM Fan Filter units can provide a sufficient number of filtered air changes to maintain a positive pressure of clean air within the controlled environment.

Because of the unique variety of sizes and options offered, SAM units can be incorporated into many different areas such as Softwall Cleanrooms, new Hardwall Cleanroom designs, and facility upgrades over conveyors or free standing machinery. They may also be incorporated into custom workbench constructions providing concentrated filtered air to meet critical clean air process requirements.

Method of Operation:

Unfiltered air is drawn into the air inlet at the top of the unit through an optional 20 x 20 Pre-Filter. This air is pulled through the motor/blower assembly into a baffled and insulated air plenum designed to evenly distribute air over and through the entire receiving surface of the HEPA Filter. Thus, SAM Fan Filter Units efficiently and quietly deliver the desired volume of cleaned air to the controlled environment. The volume of air delivered can be adjusted by means of a factory installed variable motor speed controller mounted within the unit.

Wiring Diagrams

Wiring Diagrams for all Sam Models with 280LW or MW motors

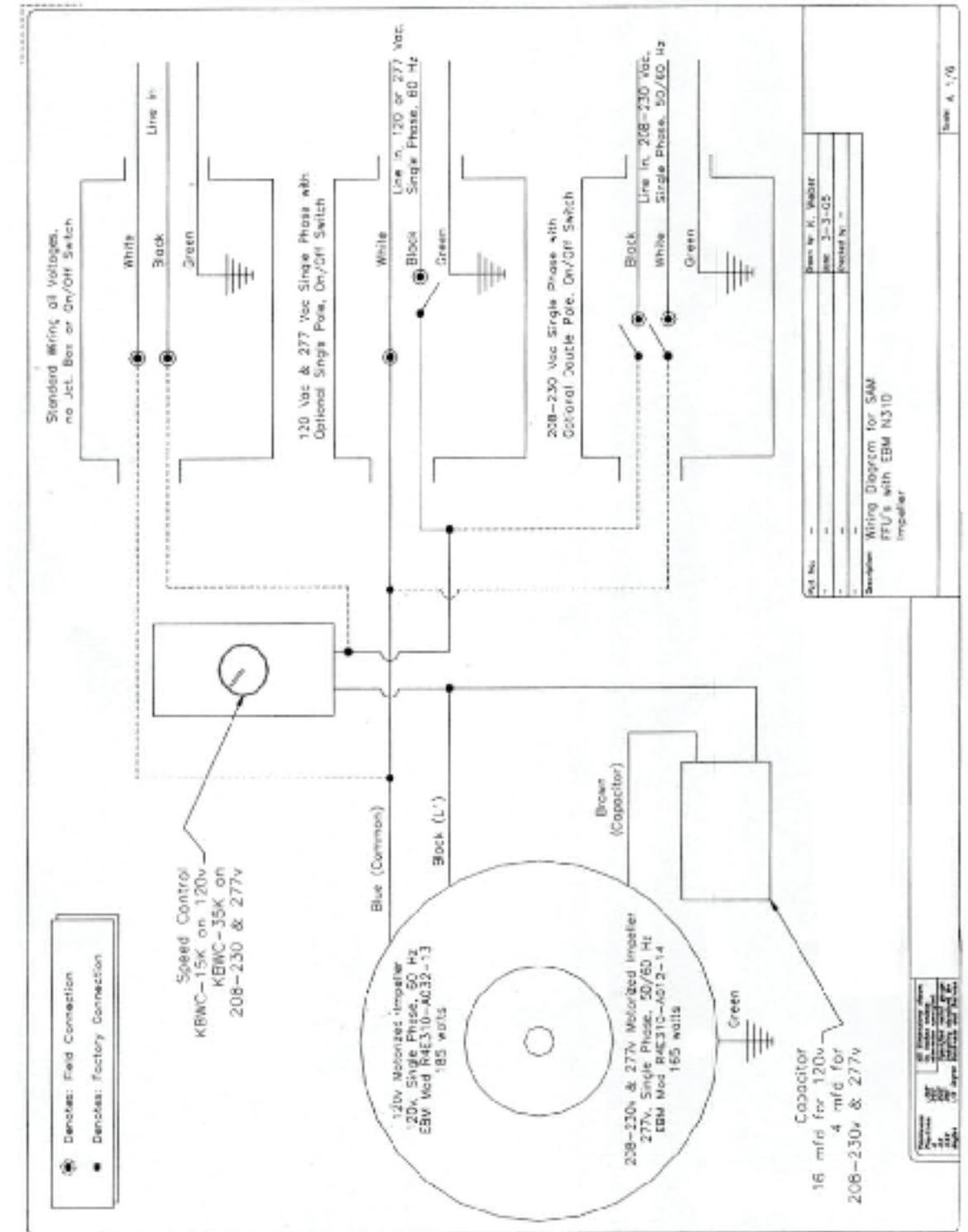

Wiring Diagrams

Wiring Diagrams for all Sam Models with 280LW or MW motors

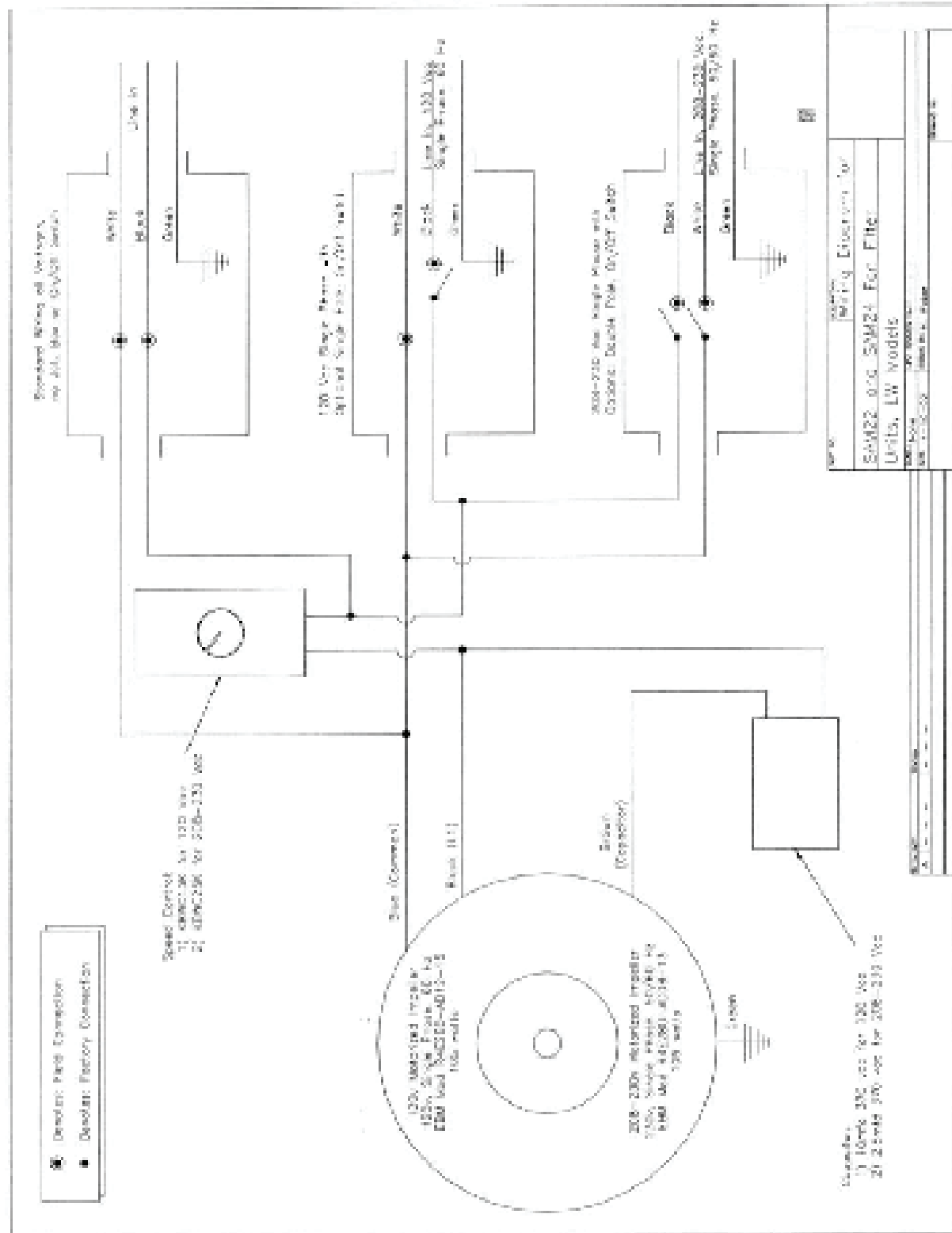

SAM Filter Unit Manual

MAINTENANCE INSTRUCTIONS

WARNING-TO REDUCE THE RISK OF FIRE, ELECTRICAL SHOCK, OR INJURY TO PERSONS, OBSERVE THE FOLLOWING:

1. Before servicing or cleaning unit, switch power off at service panel and lock the service disconnecting means to prevent power from being switched on accidentally. When the service disconnecting means cannot be locked, securely fasten a prominent warning device, such as a tag, to the service panel. Or.
2. For units optionally provided with a flexible cord and plug, unplug unit and tie cord out of reach of receptacle.

It is the intention of HEMCO Corporation to deliver a safe and reliable product that will give years of trouble-free service. To ensure optimum and safe performance and maximum product life it is imperative that a preventative maintenance program be established and adhered to and that all service is performed by a qualified technician.

Replacement parts and components should be ordered through your local Clean Rooms International, Inc. representative or distributor to insure that parts are compatible and perform as originally designed.

PREVENTIVE MAINTENANCE

A program of preventive maintenance will greatly increase fan and motor life. Inspect pre-filter, fan wheel, motor, and HEPA or ULPA filter after the first three (3) months of operation. Based on the findings, schedule periodic inspections and maintenance for:

4. Changing prefilters.
5. Cleaning fan wheel is required to insure smooth quiet operation. Periodic cleaning of all fan equipment is strongly recommended because dirt accumulation on the impeller can cause vibration which greatly increases stress and load on motor bearings.
6. Changing the HEPA or ULPA filter.

WHEN TO CHANGE A HEPA OR ULPA FILTER

Static pressure can be measured with a Magnehelic gage or manometer.

It is time to change the HEPA or ULPA filter when the pressure drop across the filter reaches two (2) times the original resistance.

HOW TO CHANGE THE HEPA OR ULPA

FILTER CAUTION: Do not touch the surface of the HEPA or ULPA filter while installing or removing the filter.

A. All units with HEPA or ULPA filter not replaceable from room side.

1. Remove SAM Unit from ceiling.
2. Remove twelve Tek screws (A) located on plenum flange.
3. Clean plenum flange surface.

4. Set plenum on top of replacement filter.
NOTE: Gasketed surface of filter should mate with plenum. CAUTION: Do not touch either side of the filter during installation.

5. With plenum centered over filter, install all screws.



SAM 24 NCR Style
Shown. All other sizes use the same method

B. CRF Series with HEPA or ULPA Filter Replaceable from Roomsides

1. Removal of unit from ceiling grid is not required.
2. Remove (2) Phillips screws (E) from the grille frame and lower grille to vertical position.
3. Remove (4) filter clips (B) from frame and pull down on the HEPA or ULPA filter to break the seal, then lower the filter straight down through the light housing.
4. Replace with new HEPA or ULPA filter and repeat each of the above steps in reverse order. CAUTION: Do not touch either side of the filter during installation.

SAM 24 CRF Style
Shown. All other sizes use the same method

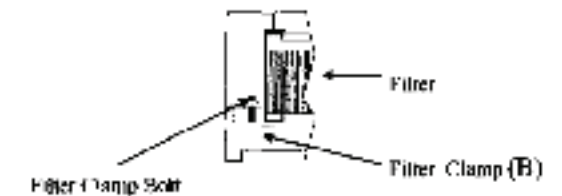
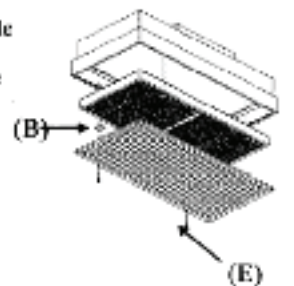

SAM Filter Unit Manual

WARRANTY

HEMCO Corporation makes no warranties, express or implied as to the products suitability for any particular use or application.

Furthermore, HEMCO Corporation will not be held liable whatsoever by any individual or group, entity or representative of an individual, group or entity by use or application of any HEMCO Corporation manufactured or supplied fan powered unit. The company also disclaims any liability for any perverse conditions or difficulty resulting from inadvertent error or from misinterpretation of the materials enclosed.

The manufacturer warrants this equipment to be free from defects in material and workmanship for a period of one year from date of purchase.

No other warranty is herein expressed and none shall be implied.

If failure appears within one year from date of purchase, the buyer must notify the HEMCO Corporation immediately. Defective product may be delivered freight prepaid to the nearest Company authorized location. HEMCO Corporation shall, at its option, correct the defect, or supply a replacement.

The liability of HEMCO Corporation shall not in any case exceed either the cost of correcting defects in the product or supplying a replacement therefore, whichever shall be less, and upon the expiration of one (1) year from date of purchase of product by customer all such liability shall terminate.

HEMCO Corporation is not responsible for damage to product due to abuse, improper installation, use other than for which originally sold, or through operation above rated load, either intentionally or otherwise of any product or party.

Under no circumstances will manufacturer be responsible for any freight (in or out), installation, or removal costs.

The foregoing warranty is in lieu of all other warranties, expressed or implied, with respect to the product, including any implied or statutory warranty or merchantability or fitness for purpose.

HEMCO Corporation shall not be liable by virtue of this warranty, or otherwise, for any consequential, incidental or special loss or damage resulting from the use or loss of use of the product.

TROUBLESHOOTING GUIDE

Problem

Possible Solution

Blower does not run:

1. Make sure the unit is properly connected to the power source.
2. Make sure switch is turned on.
3. Make sure the speed control is turned on.
4. Verify power to the outlet.
5. Check capacitor for loose connection.

Blower is running but no or very little air flow:

1. Make sure the blower is running clockwise as viewed thru the prefilter frame and blower opening.
2. Prefilter needs to be replaced.
3. HEPA filter needs to be replaced.

List of Models

LIST OF MODELS

Key: MS = MicroSound, MW = MicroWall, CRF = Coiling Resposable Filter, LW = Low Watt, P = Plastic Housing, LC = Low Cost

MFG Code	Model No. & Description	Size	Volts	Watts	Hz	Motor FLA/ Nameplate		Housing
						280	310	
SAM MicroSound Series								
12100	SAM 22 MS	2'x 2'	115V	185	60		1.8	Metal
12101	SAM 22 MS	2'x 2'	208-230V	170	50/60		0.55	Metal
12102	SAM 22 MS	2'x 2'	277V	185	60		0.50	Metal
12120	SAM 22 MS CRF	2'x 2'	115V	185	60		1.8	Metal
12121	SAM 22 MS CRF	2'x 2'	208-230V	170	50/60		0.55	Metal
12122	SAM 22 MS CRF	2'x 2'	277V	185	60		0.50	Metal
12251	SAM 24 MS	2'x 4'	115V	185	60		1.8	Metal
12252	SAM 24 MS	2'x 4'	208-230V	170	50/60		0.55	Metal
12253	SAM 24 MS	2'x 4'	277V	185	60		0.50	Metal
12254	S.A. 24 MR CRF	2'x 4'	115V	185	60		1.8	Metal
12255	SAM 24 MS CRF	2'x 4'	208-230V	170	50/60		0.55	Metal
12256	SAM 24 MS CRF	2'x 4'	277V	185	60		0.50	Metal
SAM 24 MicroSound Uprights (22 1/8" x 47 1/8")								
12240	SAM 24 MS U Size	2'x 4'	115V	185	60		1.8	Metal
12241	SAM 24 MS U Size	2'x 4'	208-230V	170	50/60		0.55	Metal
12242	SAM 24 MS U Size	2'x 4'	277V	185	60		0.50	Metal
12243	SAM 24 MS U Size CRF	2'x 4'	115V	185	60		1.8	Metal
12244	SAM 24 MS U Size CRF	2'x 4'	208-230V	170	50/60		0.55	Metal
12245	SAM 24 MS U Size CRF	2'x 4'	277V	185	60		0.50	Metal
SS SAM MicroSound Series with Stainless Steel Housings								
12106	SS SAM 22 MS	2'x 2'	115V	185	60		1.8	Stainless Steel
12108	SS SAM 22 MS	2'x 2'	208-230V	170	50/60		0.55	Stainless Steel
12109	SS SAM 22 MS	2'x 2'	277V	185	60		0.50	Stainless Steel
12110	SS SAM 22 MS CRF	2'x 2'	115V	185	60		1.8	Stainless Steel
12112	SS SAM 22 MS CRF	2'x 2'	208-230V	170	50/60		0.55	Stainless Steel
12113	SS SAM 22 MS CRF	2'x 2'	277V	185	60		0.50	Stainless Steel
12270	SS SAM 24 MS	2'x 4'	115V	185	60		1.8	Stainless Steel
12271	SS SAM 24 MS	2'x 4'	208-230V	170	50/60		0.55	Stainless Steel
12272	SS SAM 24 MS	2'x 4'	277V	185	60		0.50	Stainless Steel
12273	SS SAM 24 MS CRF	2'x 4'	115V	185	60		1.8	Stainless Steel
12274	SS SAM 24 MS CRF	2'x 4'	208-230V	170	50/60		0.55	Stainless Steel
12275	SS SAM 24 MS CRF	2'x 4'	277V	185	60		0.50	Stainless Steel
SAM MicroWall Series								
12101	SAM 22 MW	2'x 2'	115V	115	60		1.8	Metal
12103	SAM 22 MW	2'x 2'	115V	115	60		1.8	Metal
12123	SAM 22 MW CRF LW	2'x 2'	115V	115	60		1.8	Metal
12123	SAM 22 MW CRF	2'x 2'	115V	115	60		1.8	Metal
12250	SAM 24 MW	2'x 4'	115V	115	60		1.8	Metal
12250	SAM 24 MW	2'x 4'	115V	115	60		1.8	Metal
12251	SAM 24 MW	2'x 4'	208-230V	170	50/60		0.55	Metal
12252	SAM 24 MW	2'x 4'	277V	185	60		0.50	Metal
12254	SAM 24 MS CRF LW	2'x 4'	115V	115	60	1.5		Metal
12254	SAM 24 MW CRF	2'x 4'	115V	115	60	1.5		Metal
12255	SAM 24 MW CRF	2'x 4'	208-230V	170	50/60		0.55	Metal
12256	SAM 24 MW CRF	2'x 4'	277V	185	60		0.50	Metal

Key: MS = MicroSound, MW = MicroWall, CRF = Coiling Resposable Filter, LW = Low Watt, P = Plastic Housing, LC = Low Cost

MFG Code	Model No. & Description	Size	Volts	Watts	Hz	Motor FLA/ Nameplate		Housing
						280	310	
SAM LC Series								
12094	SAM 22 LC	2'x 2'	115V	185	60		1.8	Metal
12095	SAM 22 LC	2'x 2'	208-230V	170	50/60		0.55	Metal
12099	SAM 22 LC	2'x 2'	277V	185	60		0.50	Metal
12097	SAM 22 LC CRF	2'x 2'	115V	185	60		1.8	Metal
12099	SAM 22 LC CRF	2'x 2'	208-230V	170	50/60		0.55	Metal
12099	SAM 22 LC CRF	2'x 2'	277V	185	60		0.50	Metal
12310	SAM 24 LC	2'x 4'	115V	185	60		1.8	Metal
12311	SAM 24 LC	2'x 4'	208-230V	170	50/60		0.55	Metal
12312	SAM 24 LC	2'x 4'	277V	185	60		0.50	Metal
12313	SAM 24 LC CRF	2'x 4'	115V	185	60		1.8	Metal
12314	SAM 24 LC CRF	2'x 4'	208-230V	170	50/60		0.55	Metal
12315	SAM 24 LC CRF	2'x 4'	277V	185	60		0.50	Metal
SAM 26 Series								
12600	SAM 26	2'x 6'	115V	370	60		3.2	Metal
12601	SAM 26	2'x 6'	208-230V	340	50/60		1.3	Metal
12602	SAM 26	2'x 6'	277V	330	60		1.2	Metal
12603	SAM 26 CRF	2'x 6'	115V	370	60		3.2	Metal
12604	SAM 26 CRF	2'x 6'	208-230V	340	50/60		1.3	Metal
12605	SAM 26 CRF	2'x 6'	277V	330	60		1.2	Metal